

Sicherungsstift und Sicherungsboden optional erhältlich

R24,15 *lichter Abstand zwischen Glas und Pfosten

Name	Signatur	Datum	Artikelnummer	Oberfläche: Geschliffen Korn 240	
Ch. Höfig	CH	28.09.2017	3848-V4A		
Werkstoff: 1.4401 (X5CrNiMo17-12-2)			Hersteller		Blattformat
Gewicht 0,323 kg			Massstab: 1:2		Blatt 1 von 6

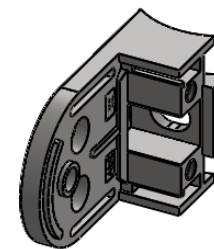
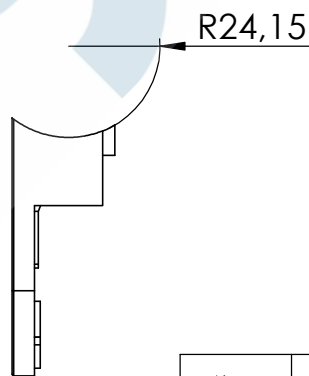
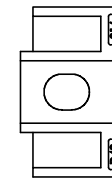
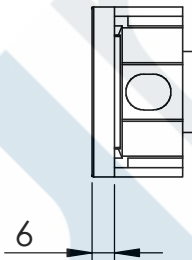
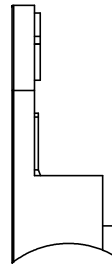
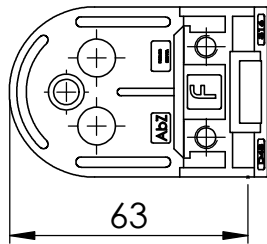

Name	Signatur	Datum	Artikelnummer	Oberfläche: Geschliffen Korn 240
Ch. Höfig	CH	28.09.2017	3848-V4A	
Werkstoff: 1.4401 (X5CrNiMo17-12-2)			Hersteller	Blattformat
			oxy nov PRO	A4
Gewicht 0,177 kg			Massstab: 1:2	Blatt 2 von 6

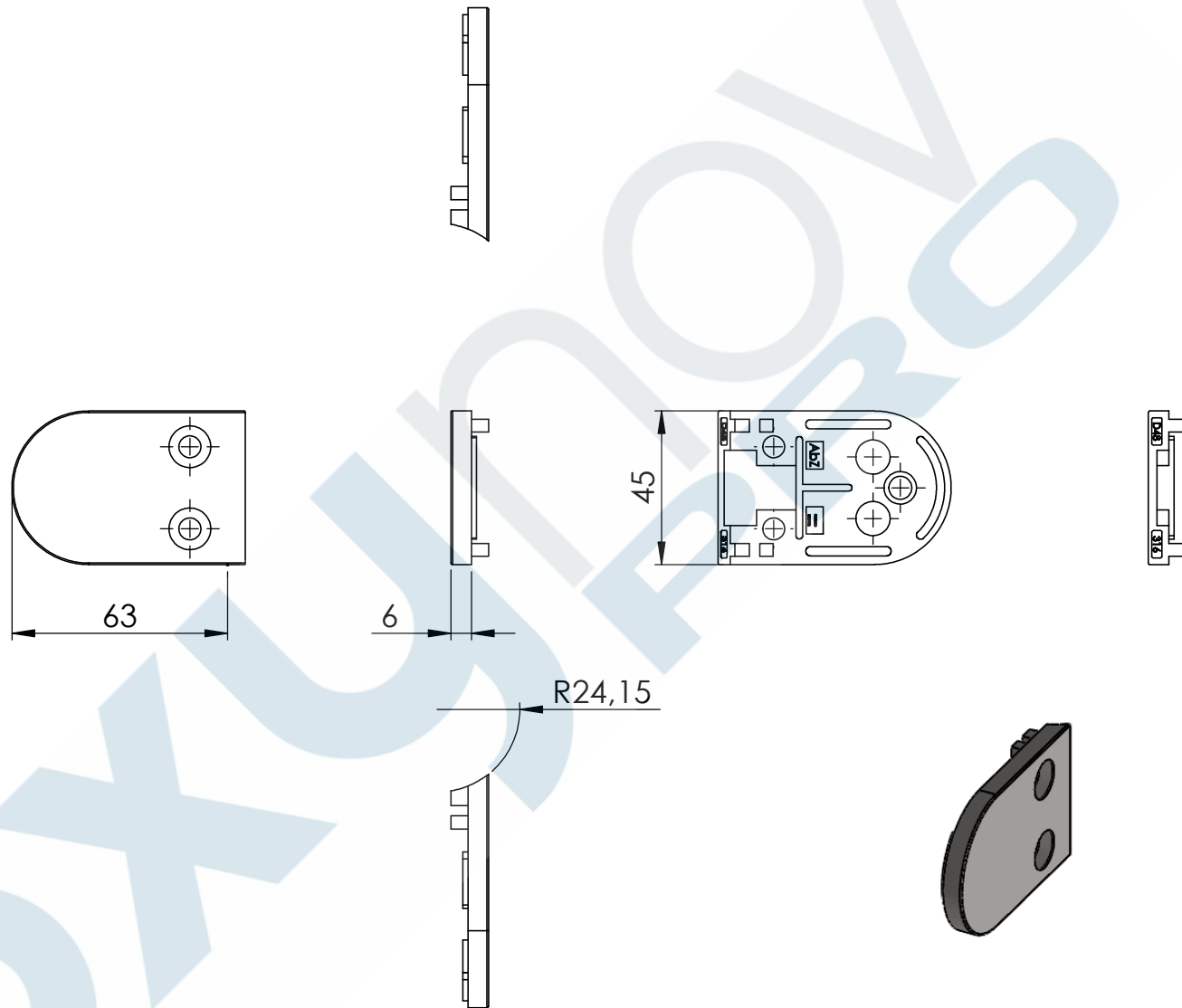

Name	Signatur	Datum	Artikelnummer	Oberfläche: Geschliffen Korn 240
Ch. Höfig	CH	28.09.2017	3848-V4A	
Werkstoff: 1.4401 (X5CrNiMo17-12-2)			Hersteller	Blattformat
			oxy nov [®] PRO	A4
Gewicht 0,114 kg			Massstab: 1:2	Blatt 3 von 6

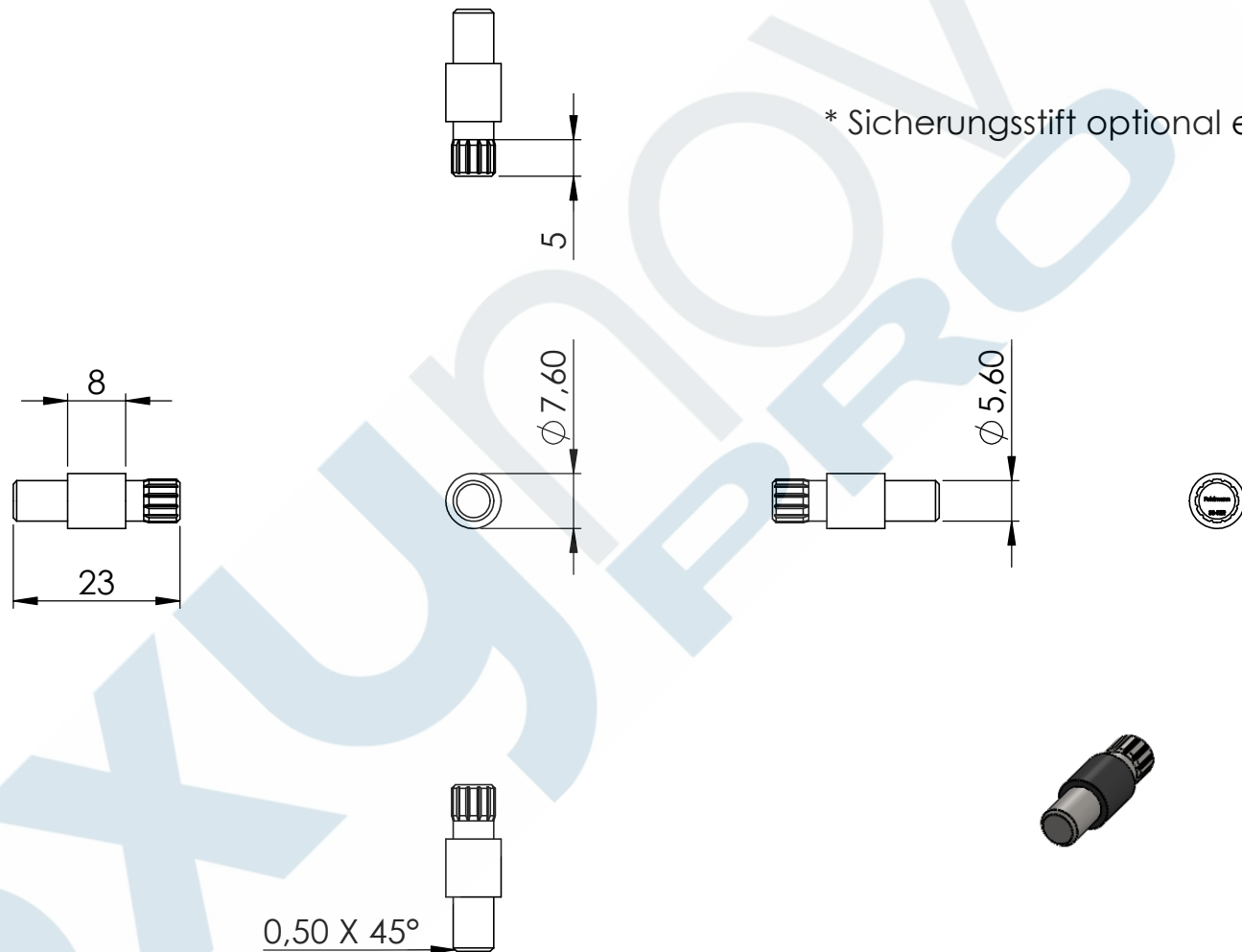

* Sicherungsstift optional erhältlich

0,50 X 45°

Name	Signatur	Datum	Artikelnummer	Oberfläche: Roh
Ch. Höfig	CH	28.09.2017	38-Stift	
Werkstoff: 1.4401 (X5CrNiMo17-12-2)			Hersteller	Blattformat
			oxy nov PRO	A4
Gewicht 0,005 kg			Massstab: 1:1	Blatt 4 von 6

*Sicherungsboden optional erhältlich

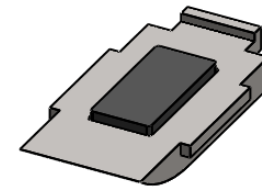
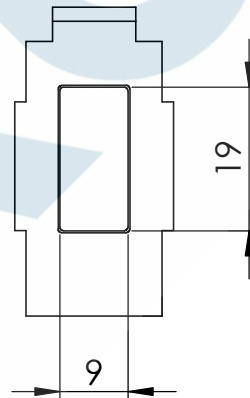
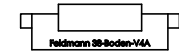
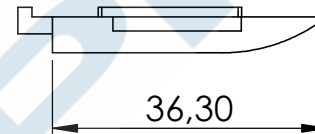
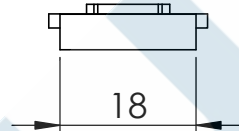
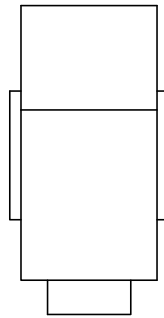
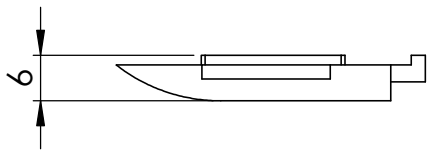

Name	Signatur	Datum	Artikelnummer	Oberfläche: Geschliffen Korn 240
Ch. Höfig	CH	28.09.2017	38-Boden-V4A	
Werkstoff: 1.4401 (X5CrNiMo17-12-2)			Hersteller	Blattformat
			oxy nov PRO	A4
Gewicht 0,023 kg			Massstab: 1:1	Blatt 5 von 6

POS-NR.	BENENNUNG	MENGE
1	3848-V4A	1
2	38-Gummi	2
3	3848-V4A	1
4	DIN 912 M8 x 20 --- 20S	1
5	DIN 7991 - M6 x 16 --- 16S	2
6	38-Stift*	1
7	38-Kappe	2
8	38-Boden-V4A*	1

*optional erhältlich

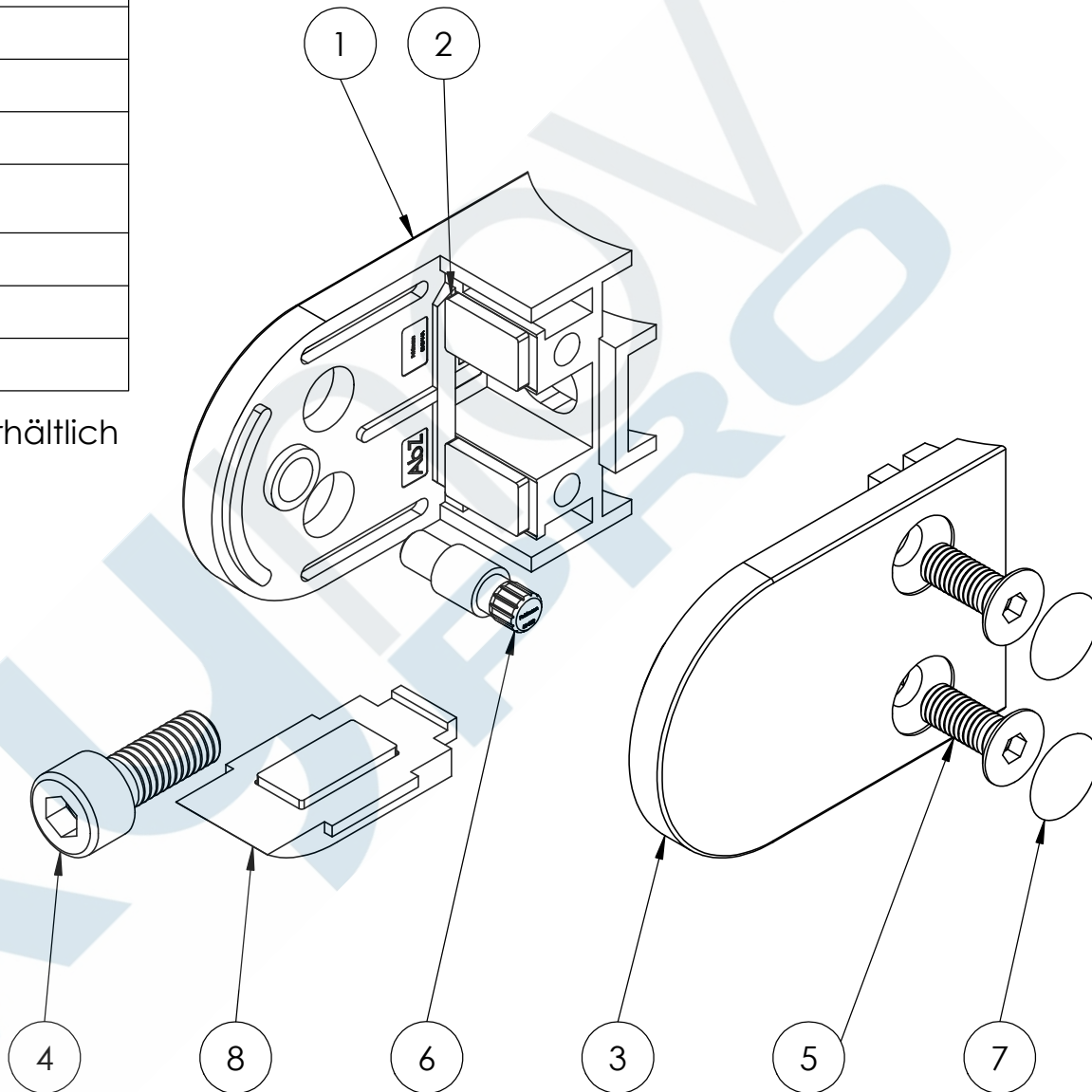

Name	Signatur	Datum	Artikelnummer	Oberfläche: Geschliffen Korn 240	
Ch. Höfig	CH	28.09.2017	3848-V4A		
Werkstoff: 1.4401 (X5CrNiMo17-12-2)			Hersteller		Blattformat
Gewicht 0.323 kg			Massstab: 1:1		Blatt 6 von 6